



众合机械

Communication and mutual help | Trust and unity
To manufacture quality products as the cornerstone

Innovation-driven, sincere to provide a full range of services
Excavator long reach boom, log grabber arm, two-section telescopic arm

Sliding arm, three-section telescopic arm,
three-section demolition arm, rock arm,
tunnel boom arm Hydraulic vibrating hammer,
bucket, pile driving arm, wood grabber, steel
grabber and ripper



众合机械

Kaiping Zhonghe Machinery Manufacturing Co. LTD

Kaiping Zhonghe Machinery Manufacturing Co. LTD



司徒莲芳 (Sophia)
Sales Manager
18127591702
Whatsapp: +8618127591702

开平市众合机械制造有限公司
Kaiping Zhonghe Machinery Manufacturing Co., Ltd
地址: 广东省开平市翠山湖新区环翠西路9号
网址: <http://www.excavatorboomarm.com>
邮箱: sophia@excavatorboomarm.com



Sophia司徒 众合加长臂厂家



Company profile

Kaiping Zhonghe Machinery Manufacturing Co., Ltd., manufacturing and trading combo, specializes in customizing excavator long reach boom arm and attachments for 5 years.

Located in Cuishanhu New District, Kaiping City, Jiangmen City, Guangdong Province, China, we has more than 14000m² steel structure standardization workshop, and a large number of high precision processing equipment, such as CNC plasma cutting machine, CNC flame cutting machine, milling edge machine, etc.

We have a strong and cohesive team. At present, there are more that 60 experienced technical staffs, 30 welding workers with over 7 years experience, 15 senior designers and a high-tech R&D team.

With years of experience in engineering equipment manufacturing, we independently R&D and produce different kinds of excavator boom arms and attachments with CE-certification, such as, long reach boom, 3-stage demolition boom, 2/3-section telescopic boom, standard/strengthen/rock bucket, gripper, ripper, etc., which are widely used in a variety of engineering fields, like Machinery Repair Shops, Farms, Construction works , Energy & Mining, and Other.

Our annual output of various types of excavator boom arms can reach 600 sets. We supply products with high quality and moderate price, which is sell well in more than 40 countries and areas.

We adhere " Merit Quality, Sincerity Management and Customer Satisfaction", honestly greet customers from home and abroad to cooperate with us.



CATALOGUE

Company profile	01	Sorting Grab	15
Long Rech Boom Arm	03	Orange Peel Grapple	16
Three-section demolition boom	04	bucket	17
Two-section demolition arm	05	Excavator Rake	18
Excavator pile driving arm	06	Clamshell Bucket	19
Pile Hammer	07	Tilting Bucket	19
Sliding arm	08	Hydraulic Power Thumb	20
Two-segment telescopic arm	09	Clamp Bucket	20
Telescopic log collecting arm	10	Hydraulic Pulverizer	21
3-section Telescopic arm	11	Multi Crusher/Multi Shear	22
Split Ripper Arms	12	Hydraulic Quick Hitch	23
Tunnel boom	13	Tilt Quick Hitch	24
Standard boom&arm	13	Single Cylinder Shear	25
Hydraulic Steel/Rock Grab,B	14	Double Cylinder Shear	25
Hydraulic rotary wood grip	15	Grid Bucket	26
		Cleaning Bucket	26

Long Reach Boom Arm

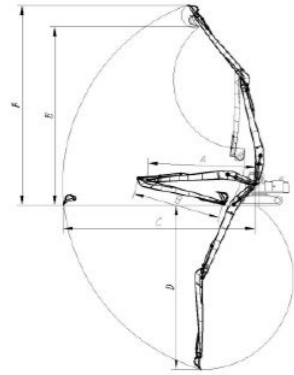

Long Reach Boom Arm Accessories			
name	Unit	main material	warranty(day)
Boom	1	Q355B	360
Arm	1	Q355B	360
Bucket	1	Q355B	90
Bucket cylinder	1	-	180
Linkage assembly	1	Q355B	180
Pin	6	40Cr	0
High-pressure hose	9	4 layers wire ring	0
Lubrication pipe	5	1 layer wire ring	0
Steel tube	6	20#steel	0

Weight	11-15T	20-25T	20-30T	35-40T	40-45T	40-50T
Total Length(mm)	13000	15400	18000	20000	22000	24000
Boom(A)(mm)	7250	8220	10000	11000	12000	13000
Arm(B)(mm)	5750	7180	8000	9000	10000	11000
Maximum Digging Radius(C)(mm)	11200	14500	17300	19200	21300	23000
Maximum Digging Depth(D)(mm)	9000	11300	13000	14900	16000	17900
Maximum Unloading Height(E)(mm)	7550	10400	11800	12900	14000	15200
Maximum Digging Height(F)(mm)	9350	12600	14000	15200	17000	18100
Bucket Volume(m)	0.15-0.3	0.4-0.6	0.4-0.7	0.6-1.2	0.5-1.0	0.5-1.1

Product description:

1. Arm cylinder use the original one to save cost, we can provide one if needed.
2. Product advantages:
 - Good quality as better material, experienced worker and professional engineer.
 - Supply customization service according to customer requirements.
 - Max work range and the max digging height are larger as angle of boom and arm can reach 163 degrees.
3. Working conditions: municipal engineering, subway construction, river dredging, reservoir cleaning and other water conservancy projects.



Three-section demolition boom

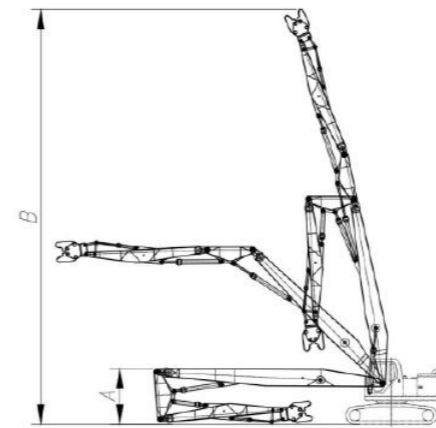

Three-section Demolition Boom Accessories			
name	Unit	main material	warranty(day)
Boom	1	Q355B	360
Middle arm	1	Q355B	360
Arm	1	Q355B	360
Bucket	1	Q355B	90
22 ton Bucket cylinder	1	-	180
Linkage assembly	1	Q355B	180
Pin	8	40Cr	0
High-pressure hose	22	4 layers wire ring	0
Lubrication pipe	5	1 layer wire ring	0
Shut-off valve	10	-	0

Excavator Ton	Total Length(mm)	(A)Transport Height(mm)	(B)MaximumLifting Height(mm)	Limit weight of hydraulic shear(kg)	Cylinder(Ton)	Add Weight(Ton)
25T	16000	3160	14900	2000	20T	4T
30T	18000	3300	17000	2000	20T	4.5T
35T	20000	3300	19000	2000	20T	4.5T
40T	22000	3400	21050	2000	20T	5T
45T	24000	3400	23100	2000	20T	5T

Product description:

1. Product advantages:
 - Good quality as better Q355B material, experienced worker and professional engineer.
 - Supply customization service according to customer requirements.
 - Open angle of large and medium arm can achieve 180°, which higher the overall removal height.
2. Working conditions: urban village reconstruction, building demolition, old factory building reconstruction, high-rise demolition project, etc.





Two-section demolition arm

Model	Boom Length	Arm length	Fold Height	Max Work range	Max reach height	Max Cut depth	Bucket cylinder	Breaker chisel diameter	Self weight
12T	7.8m	5.2m	2.9m	12m	13m	7m	6T	65	3T
20T	9.5m	6.5m	3m	15m	16m	10m	12T	100	4T
25T	10.5	7.5	3m	17m	17m	11m	20T	100	4.2T
30T	11.5m	8.5m	3.2m	19m	20m	13m	20T	135	6T
35T	12.5m	9.5m	3.2m	21m	22m	15m	22T	135	6.5T
40T	13.5m	10.5m	3.5m	23m	24m	17m	22T	140	7.5T
45-50T	15m	11m	3.5m	25m	26m	18.8m	25T	140	8.2T

Product description:

1. Product advantages:

Good quality as better material, experienced worker and professional engineer.

Supply customization service according to customer requirements.

Open angle of boom and arm can achieve 160°, which higher the overall removal height.

2. Configuration: 1pcs boom, 1pcs arm, 4pcs pins, 2 stop valves, 1pcs bucket cylinder, 1 kit high pressure hose and 1 kit linkage.

3. Suitable working conditions for building demolition arm: reconstruction in urban villages, building demolition, old factory building renovation, high-rise demolition project, etc.

Excavator pile driving arm

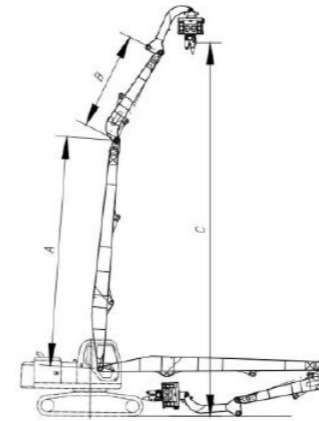

Three-section Demolition Boom Accessories			
name	Unit	main material	warranty(day)
Boom	1	Q355B	360
Arm	1	Q355B	360
High-pressure hose	9	4 layers wire ring	0
Lubrication pipe	5	1 layer wire ring	0
Shut-off valve	3	-	0

Excavator Ton	Total Length(mm)	(A)Boom(mm)	(B)Arm(mm)	(C)Piling Height(mm)	Counterweight(Ton)
30-36T	13800	10000	3800	15400	3T
30-36T	15000	10500	4500	17100	5T
40-45T	15800	11000	4800	17900	3T
40-45T	16800	11500	5300	18500	5T-6T
45-50T	19000	12500	6500	21000	6T-7T

Product description:

1. Notices: All pins and linkage assembly use the original one, and the high pressure hose of the arm cylinder also use the original one. The steel pipe above the large arm is designed in sections to facilitate the later maintenance.

2. Product advantages:

Good quality: the lower cover plate of the boom and arm is thickened, the interior of the box adopts two-way reinforcement plate design, the small arm ear's bearing position is treated with segmented thickened plate, which improves the overall service life of the pile arm.

Supply customization service according to customer requirements.

Open angle of boom and arm can achieve 160°, and the Angle of the large arm and the base can reach 88°, which higher the overall removal height.

3. Working conditions: municipal engineering, water diversion engineering, subway, road and bridge and other engineering projects.

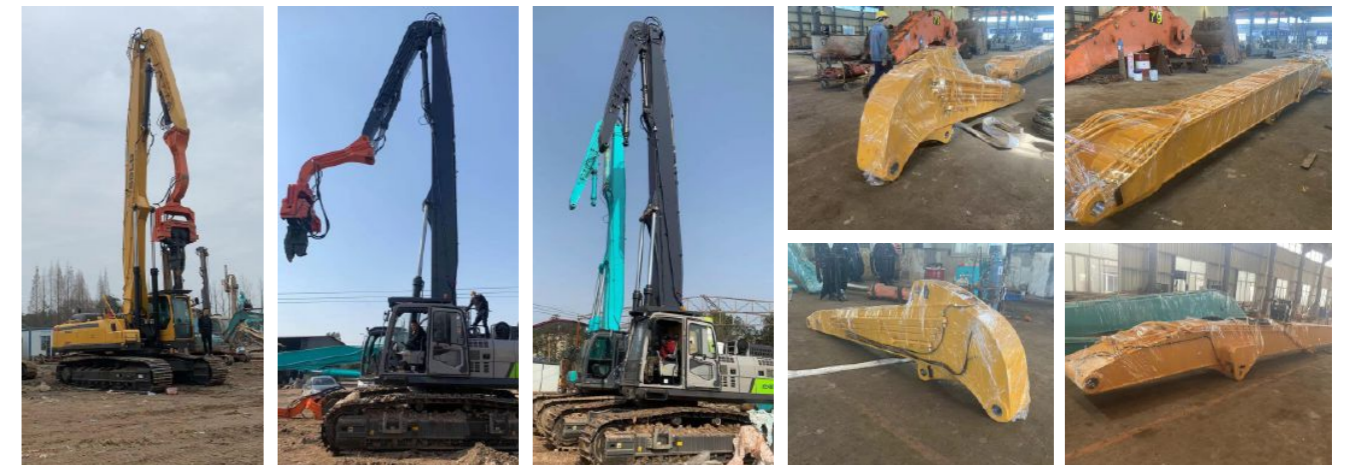

■ Pile Hammer

- Applicable objects: various types of pipe, steel plate, etc.
- Main features: using Q345 manganese plate steel, high strength and corrosion resistance;
- The pin is made of 42CrMo alloy steel, with built-in oil passage, high strength and good toughness;
- Rotary motor adopts Swiss imported motor;
- The oil seal adopts the oil seal imported from Eaton in the United States to extend the service life;
- The shock absorber adopts Korean Autox, with good toughness and fatigue resistance;
- Integrated design, safe and stable, low failure rate.

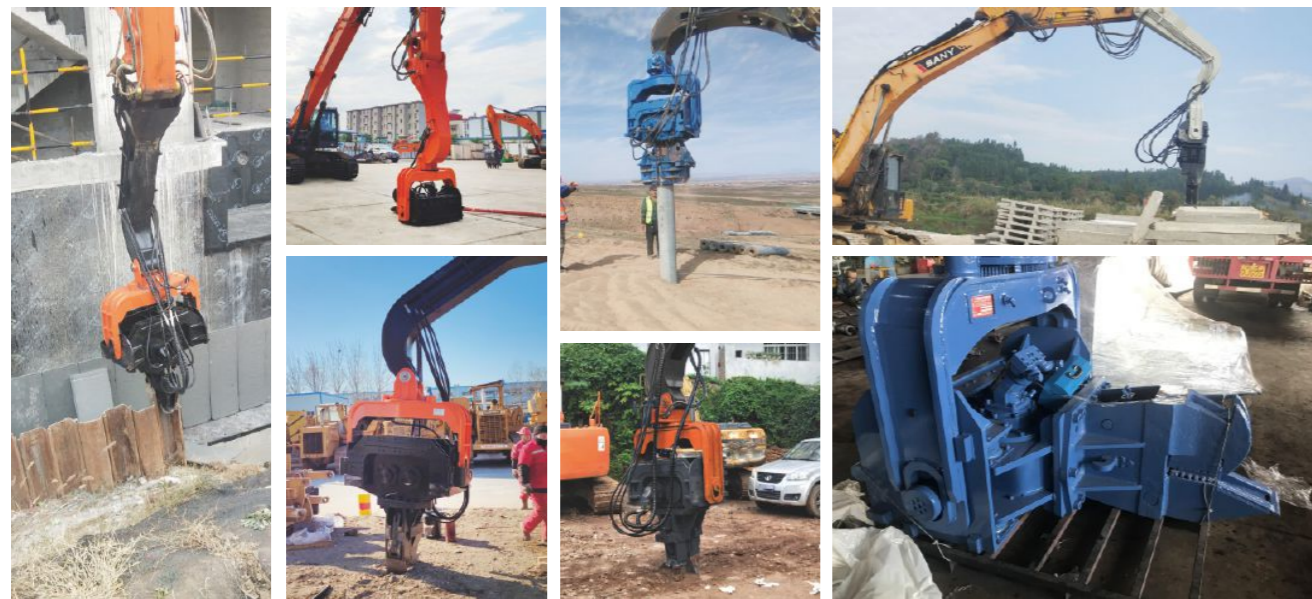
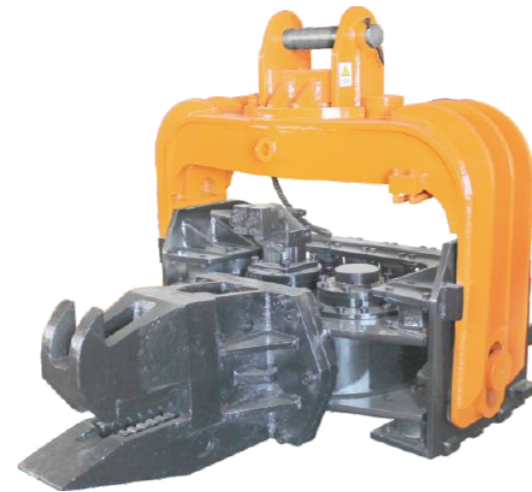

Item/Model	Unit	ZHP150	ZHP250	ZHP330	ZHP350	ZHP450	
Suitable Excavator	ton	12-17	18-25	30-40	40-50	40-65	
Eccentric Moment	Nm	32	36	50	65	85	
Frequency	rpm	2500	2800	2800	2800	2800	
Centrifugal Force	kN	172	265	420	580	750	
Working Pressure	bar	300	300	320	320	320	
Working Flow	lpm	120	155	168	210	255	
Max Turning	degree	180	180	180	180	180	
Weight	Main Body	kg	1300	1900	2650	2900	3000
	Extension boom	kg	260	400	650	650	650
	Total Weight	kg	1560	2300	3300	3550	3650

■ Sliding arm

Model	Max work range	Max reach depth	Fold height	Bucket Capacity	Self weight
12-15T	10000mm	7000mm	2900mm	0.3	1600kg
20-25T	13000mm	10000mm	3000mm	0.6	2500kg
30-35T	15000mm	12000mm	3200mm	1	3500kg

Product description:

1. The sliding arm is made of telescopic cylinder, the upper sliding arm and the bottom base arm. The upper sliding arm is installed on the lower base arm. The base arm have two-side roller and the channel rail, and the upper sliding body is driven by the telescopic cylinder.
2. The upper sliding arm is connected to the telescopic cylinder piston side, the tube side of the cylinder is fixed to the bottom base arm. The external expansion arm has a large force, simple structure, can adjust the length freely, easy to operate, suitable for all kinds of different case. But the length adjust range is smaller, within 4 meters.
3. Product advantages: the first double limit design reduces the running vibration of the sliding arm and improves the service life of the cylinder; The sliding device is changed from the previous pulley design to the slide design to reduce the failure rate, and the wear-resistant rubber slider is easier to replace and maintain.
4. Applicable working conditions: excavation of subway, pipe jacking and caisson.





Two-segment telescopic arm

Model	Max work range	Max reach depth	Fold height	Bucket Capacity	Self weight
12-15T	11m	10m	2.9m	0.3	2T
20-25T	15m	13.8m	3m	0.4	3.4T
30-35T	16m	14.8m	3.2m	1	5T

Product description:

1. Construction advantages: larger work range and very deep operation depth. The telescopic arm structure can reach a far distance, can reach a deeper working depth, which is much bigger than standard excavator arm. Can construction work directly over some obstacles. The expansion arm device can cross the small ditches and steps to complete the construction requirements. Because to the negative amplitude Angle, the ditch can also be cleared or repaired, leveled and other operations, so it is suitable for outdoor working.
2. Good job safety performance. The telescopic arm excavator has very big work range. So When working on the uneven road surface, it can stop far away from the stacking point, and use the expansion and amplitude change action to complete the construction operation.
3. Product advantages: the arm cylinder is made of high strength 700; the built-in telescopic oil pipe can effectively avoid the pipeline damage from obstacles.

Telescopic log collecting arm

Model	length	Weight	Max Work range	Max load weight	Grab self weight	Counter weight
12-15T	23m	1.5T	20m	0.6T	120kg	0
	25m	1.8T	22.5m	0.5T	120kg	0
	28m	2.2T	25m	0.4T	120KG	0.5T

Product description:

1. Structure composition:

Outer arm cylinder: small arm synchronous steel wire; synchronous steel wire rope fixed seat; synchronous pulley group; retractable pulley; retractable oil cylinder; retractable steel wire rope group; retractable oil cylinder iron pipe; clamp iron pipe; pulley rail; fixed ear seat, fixed ear seat connection rod.

Middle arm barrel: clamp pipe hose; clamp pipe synchronous pulley; small arm barrel synchronous pulley; buffer vibration glue; and internal middle arm synchronous for fixed pulley.

Small arm tube: horse head; clamp pipe; expansion steel wire fixed ear seat; small arm synchronous steel wire rope fixed ear seat.

2. Product advantages:

arm barrel using high strength manganese plate, pulley group all using steel, bearings using Luoyang bearing, all wire rope using multiple wire rope; optimize arm barrel design, the expansion arm need not replace the wire rope and pulley.

3. PWorking condition:

mainly used for forestry deforestation operations.





3-section Telescopic arm

Model	Length	vertical digging depth	Transportation Height	Bucket Capacity	Working Weight
20-25T	18m	18m	3m	0.5m ³	3.4T
30-35T	28m	28m	3.2m	2m ³	7T
40-50T	32m	32m	4m	2.2m ³	9T

Product description:

1. Structure composition: The three-section telescopic arm is the same as the log collecting arm, and the telescopic arm usually carries a clamshell bucket or GP bucket.
2. Product details: The telescopic arm can be made of Q690D-Q960 material according to the requirements, with much deeper excavation depth, simple and convenient operation, safe and reliable.
3. Scope of application: subway, foundation pit, basement, tunnel and other narrow deep excavation conditions.



Split Ripper Arms

Model	Boom/arm length	Total weight of boom and arm	Max work range
30-40T	5000\3100	12T-16T	6000
40-50T	5000\3800	16T-18T	6000
50-60T	5500\3800	25T-30T	6700
60-100T	6000\4100	30T-40T	7500

Product description:

1. Configuration: boom, arm, one bucket cylinder, one arm cylinder, two rippers, 8 pins, four high pressure hose, three grease pipe, one kit Linkage.
2. Effective: For the rock arm modified by 45-ton excavator, the front tip crushing force can be the same as the crushing force of 165mm chisel breaker, and the efficiency is 6 times more than 165mm chisel breaker.
3. Product advantages: the standard excavator boom&arm with ripper, ripper force is very lower, the standard excavator boom&arm with breaker is low efficient, the excavator ripper arm can have both high level rip force and high efficient, much more efficient. Large construction sites will generally have large bulldozers D11, general bulldozers relative to the corner place, the bulldozers cannot reach and handle, the rock arm is not limited by the position, can solve these problems, high efficiency. The maintenance cost of the ripper arm is lower than the general standard arm, just add grease daily. Ripper arms can generally be applied to medium and high weathered rock, sandstone and other rock hardness is not higher than 45 MPa. Compared with D11 excavator, rock arm has lower cost, shorter recovery cost cycle, and can be more profit.

Tunnel boom

Product description:

- 1.Product features: Tunnel boom is customized according to the tunnel height and other narrow working conditions, the shorter size arm can carry bigger breaker(or other attachments).The arm is solid heavier design, which can more effectively to press the breaker, reducing the rebound in working.
- 2.Production advantages: the bucket cylinder of the tunnel boom is placed under the boom&arm, to reduce the damaging caused by accident, and the extend angle of the tunnel arm can reach 170 degrees ,so can reach to the maximum height within the shortest distance.Both the boom and arm are Integrated Lubrication.



Standard boom&arm

Model	Boom Length	Arm length	Fold Height	Self weight
6T	3700mm	2200mm	2175mm	730kg
10T	4400mm	2910mm	2550mm	1800kg
12T	4600mm	3125mm	3040mm	2000kg
20T	5700mm	3750mm	3140mm	2700kg
25T	6150mm	4050mm	3140mm	3500kg
30T	6470mm	4118mm	3280mm	3850kg
35T	6430mm	4185mm	3280mm	3900kg
40T	7050mm	4425mm	3400mm	5100kg
45T	7120mm	4430mm	3400mm	5600kg

product details:

High strength Q355 steel, Keep same as the original design, good welding , using the national high level hydraulic steel pipe, the performance is the same as the original one.



mechanical claw

Model	Sort		Maximum Opening Length	Weight		Material
6-10T	New-style claw	Old-style claw	1450mm	200kg	300kg	Q355B
12-17T			1700mm	400kg	600kg	Q355B
20-25T			1950mm	800kg	1000kg	Q355B
30-35T			2400mm	2400kg	2600kg	Q355B

Old-style claw



New-style claw



product presentation:

Made of high-strength manganese steel, reasonable design and exquisite processing technology, the applicable life is longer, the new type is more durable and practical than the old type. Applicable occasions: waste metal treatment, stone clip, wood loading and unloading and handling.

Hydraulic Steel/Rock Grab,B

Applicable objects:simple soil loosening, cleaning debris, loading and unloading.

Main features:NM400 steel,light weight and wear-resistant;

The pin is made of 42CrMo alloy steel,with built-in oil passage,high strength and good toughness;

Rotary motor imported from Switzerland;

Use vertical car motor rotation system,360° rotation,with car brake function;

The oil cylinder adopts honing tube,imported HALLITE oil seal,short working cycle and long life;

Single-cylinder connecting rod design,light texture and convenient gripping.

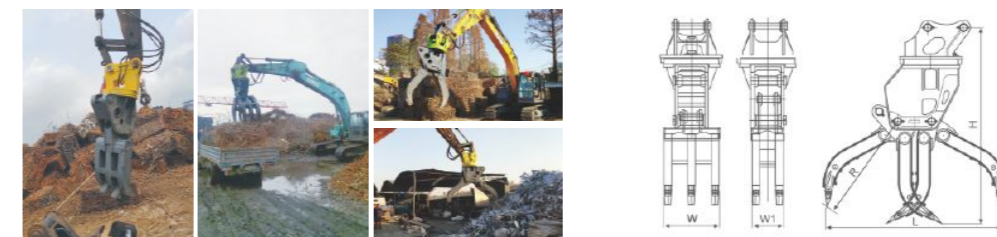

Item/Model	Unit	ZHSR06B	ZHSR08B
Suitable Excavator	ton	12-16	17-23
Weight	kg	1015	1750
L	mm	1700	2100
H	mm	2050	2400
W	mm	560	720
W1	mm	324	420
R	mm	1230	1430
Working Pressure	bar	150-170	160-180
Set Up Pressure	bar	190	200
Working Flow	lpm	90-110	100-140

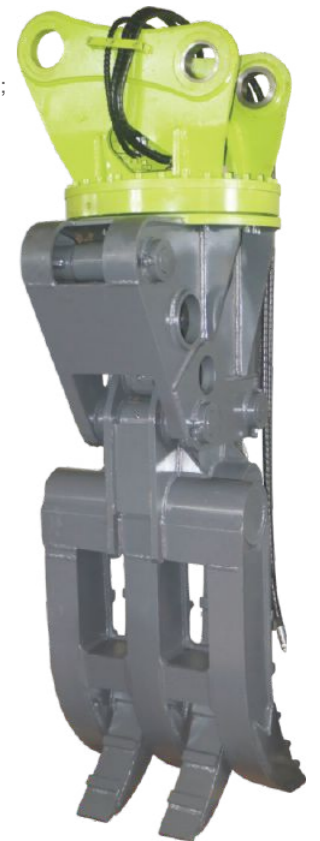



Hydraulic rotary wood grip

Model	Name	Maximum opening length	Weight	Material
6-10T	Hydraulic Rotary Wood Grabber	1450mm	500kg	Q355B
11-16T		1700mm	800kg	
20-24T		1950mm	1100kg	
25-30T		2100mm	1300kg	
33-36T		2400mm	1500kg	
37-42T		2500mm	1800kg	
45-55T		2600mm	2100kg	

product presentation:

Hydraulic rotary wood grip can rotate for 360 degrees, dealing with various working conditions more handy, and it is also very convenient to operate. Adopt imported rotary motor, high quality domestic turntable, high quality domestic oil cylinder.

Applicable occasions: waste metal disposal, stone and wood loading and unloading and transfer

Sorting Grab

Applicable object: all kinds of large-scale, bulk materials loading and unloading or handling operations.

Main features: using Q345 manganese plate steel, high strength and corrosion resistance; The pin is made of 42CrMo alloy steel, with built-in oil passage, high strength and good toughness;

Rotary motor imported from Switzerland; The oil cylinder adopts honing tube, imported HALLITE oil seal, short working cycle and long life.

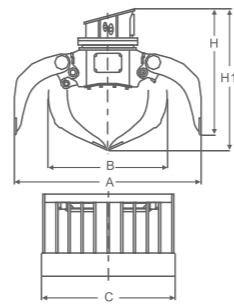

Item/Model	Unit	ZHSG04	ZHSG06	ZHSG08	ZHSG08	ZHSG10
Suitable Excavator	ton	6-12	12-18	18-25	18-25	25-32
Weight	kg	470	1050	1370	1370	1700
Operating Capacity	m ³	0.60	0.60	0.80	0.80	1.00
A	mm	1730	2175	2700	2700	3300
B	mm	960	1200	1500	1500	1880
C	mm	595	745	935	935	1160
H	mm	1350	1700	2100	2100	2650
H1	mm	1570	1970	2400	2400	3080
Driving Pressure	bar	300	300	300	300	300
Driving Flow	lpm	180-230	180-230	200-250	200-250	250-300
Rotating Motor	Set Up Pressure	bar	120	120	120	120
	Motor Flow	lpm	30	30	30	30
	Frequency	r/min	16-18	16-18	16-18	16-18

Orange Peel Grapple

Applicable objects: loading, unloading, and handling of bulk stone, steel, wood and other materials.

Main features: NM500 steel, light weight and wear-resistant;

The pin is made of 42CrMo alloy steel, with built-in oil passage, high strength and good toughness;

Rotary motor imported from Switzerland, vertical cart motor rotation system, 360 rotation, cart brake function;

The oil cylinder adopts honing tube, imported HALLITE oil seal, short working cycle and long life.



Orange Peel Grapple A



Orange Peel Grapple B

Item/Model	Unit	ZHO04A	ZHO06A	ZHO08A	ZHO06B	ZHO08B
No. of Jaw	piece	4/5	4/5	4/5	4/5	4/5
Suitable Excavator	ton	6-9	10-17	18-25	10-17	18-25
Weight	kg	355/420	900/1000	1650/1900	850/1000	1700/1950
Max Open Jaw	mm	1200	1600	2050	1900	2500
Height of Opened Grapple	mm	1000	1500	1700	1550	2000
Working Pressure	bar	200	260	320	260	320
Working Flow	lpm	50-100	60-120	200-250	60-120	200-250
Capacity	m ³	0.3	0.4	0.8	0.5	1

bucket

product presentation:

1. The most common classification of digging bucket is divided into rock bucket and earth-moving bucket, which are designed according to different working conditions. Compared with the rock bucket, the material is relatively thin, the opening of the excavation bucket is relatively large, the excavation force is relatively small, and the bucket capacity is large. Rock bucket, material and production process requirements are higher, the opening of the bucket is relatively small, the depth of the bucket is large, the excavator force should be large, the working condition is worse.
2. The material of the earth bucket is Q345B material, the most important two points for the bucket is the material and welding, the earth bucket made by our company all use Q345B material, welding is gas welding, skilled professional welding workers, welding technology is better, welding path full without virtual welding, more durable.
3. The material of the rock bucket is Q345B + wear-resistant material, which is reinforced in the bucket, bucket Angle and horizontal reinforcement plate, and multi-layer overlapping welding.



Ripper

Supporting Models	Name	Main Board Thickness	Weight	The Model Of Tooth Holder	Material
6-10	Ripper	60	300	PC200	Q355B
11-16		60	400	PC300	
17-20		80	500	PC400	
21-28		80	700	PC400	
30-38		100	800	D90	
40-50		120	1000	D90	
50-70		150	1500	D11	

Product description:

loose soil device is divided into single teeth and multi-teeth, loose soil device cutting ability is strong, the excavation force is concentrated as a point, can effectively excavate hard soil, weathered rock, gravel, convenient excavation bucket loading and unloading.



Excavator Rake

Applicable object: loose work in hard geological layer, frozen soil layer, soft stone, weathered stone and other geology.
 Main features: using Q345 manganese plate steel, high strength and corrosion resistance;
 The pin is made of 42CrMo alloy steel, with built-in oil passage, high strength and good toughness.



Item/Model	Unit	ZHER02A	ZHER04A	ZHER06A	ZHER08A	ZHER10A	ZHER02B	ZHER04B	ZHER06B	ZHER08B	ZHER10B
Suitable Excavator	ton	4-6	5-9	10-16	17-24	25-32	4-6	5-9	10-16	17-24	25-32
Weight	kg	240	360	700	2000	2300	160	320	590	1050	2050
Length	mm	1010	1410	1830	2200	2600	1000	1320	1825	2200	2500
Width	mm	360	485	635	785	945	430	575	750	925	1125
Height	mm	880	1175	1460	1710	2050	940	1170	1460	1705	2130

Clamshell Bucket

Applicable object: loading and unloading of broken and sandy materials in bulk.
 Main features: NM500 wear-resistant steel, high strength and wear resistance;
 The pin is made of 42CrMo alloy steel, using heat treatment technology, built-in oil passage, high strength and good toughness;
 Double-cylinder connecting rod design, using honing tube, imported HALLITE oil seal, short working cycle, long life and flexible operation.

Item/Model	Unit	ZHCS04	ZHCS06	ZHCS08	ZHCS10
Suitable Excavator	ton	7-11	12-18	18-25	26-35
Weight	kg	800	1200	2000	2300
Opening	mm	1000	1500	2200	2300
Working Pressure	bar	180	210	250	250
Set Up Pressure	bar	250	290	320	340
Working Flow	lpm	190	210	220	240



Tilting Bucket

Product introduction

1. High strength materials are used, which are suitable for various models with 4 ~ 30 tonnage;
2. The tilt angle is 0-45 degrees, which is convenient and fast;



Excavator Model (ton)	G.W. (kg)	Hydraulic Oil Flow Rate (L/min)	Work Pressure(bar)	Bucket Capacity (cbm)
6	450	10-20	30-210	0.4
12	750	10-20	30-210	0.6
20	950	10-20	30-210	0.8
30	1200	10-20	30-210	1.4

Hydraulic Power Thumb

Applicable object: auxiliary operation for material grabbing.
 Main features: using Q345 manganese plate steel, high strength and corrosion resistance;
 The oil cylinder adopts honing tube, imported HALLITE oil seal, short working cycle and long life.



Item/Model	JSPT02	JSPT04	JSPT04	JSPT06	JSPT08
Suitable Excavator	2 4-6	2 7-11	2 7-11	2 12-16	2 17-23
Weight	3 500-800	3 800-1300	3 800-1300	3 900-1500	3 1000-2000
Opening	4 300-600	4 400-800	4 400-800	4 500-1000	4 600-130
Working Pressure	5 180-300	5 200-280	5 200-280	5 250-380	5 260-400
Set Up Pressure	6 110-140	6 120-160	6 120-160	6 150-170	6 160-180
Working Flow	7 35-55	7 50-100	7 50-100	7 90-110	7 100-140

*具体尺寸根据挖斗数据不同略有出入。

Clamp Bucket

Applicable objects: excavation and clamping of gravel sites and loading and unloading of various small and medium materials.
 Main features: using Q345 manganese plate steel, high strength and corrosion resistance;
 The pin is made of 42CrMo alloy steel, with built-in oil passage, high strength and good toughness;
 Rotary type uses Swiss imported rotary motor;
 The oil cylinder adopts honing tube, imported HALLITE oil seal, short working cycle and long life.



Item/Model	Unit	ZHCB02	ZHCB03	ZHCB04	ZHCB06	ZHCB08	ZHCB10
Suitable Excavator	ton	2-3	4-6	7-11	12-16	17-23	24-30
Neight	kg	180	360	520	840	1430	1860
Max Jaw Opening	mm	818	1150	1380	1550	2220	2235
Working Pressure	bar	100-130	110-140	120-160	150-170	160-180	160-180
Set Up Pressure	bar	150	170	180	190	200	210
Working Flow	lpm	25-40	30-55	50-100	90-110	100-140	130-170
Cylinder Volume	ton	4.0	5.4	5.4	8.2	10.0	12.0

Hydraulic Pulverizer

Applicable objects: Demolition operations such as separating reinforced concrete.
 Main features: Made of Swedish Hardox 500 steel, lightweight and wear-resistant;
 The pin is made of 42CrMo alloy steel with high strength and toughness;
 Rotary type uses Swiss imported rotary motor;
 Oil cylinder adopts honing tube, imported HALLITE oil seal, long life;
 The knife block is made of wear-resistant alloy steel, which is resistant to high temperature and deformation.



Hydraulic Pulverizer

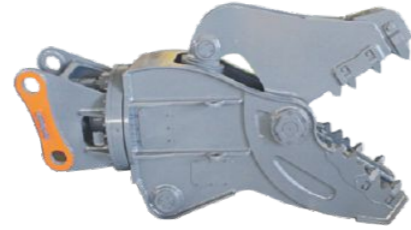

heavy crushing shear



Rotating Pulverizer



Item/Model	Unit	ZHH80M	ZHH80M	ZHH380D	ZHH180D	ZHH280C	ZHH180X	ZHH280X	ZHH380X	ZHH280E
Suitable Excavator	ton	4-8	4-8	32-40	9-16	18-30	9-16	18-30	32-40	18-30
Weight	kg	400	400	2100	800	1600	1100	1900	2500	1600
Opening	mm	410	410	910	570	880	570	810	910	880
Blade Length	mm	130	130	230	130	170	130	230	230	170
Height	mm	1310	1310	2420	1520	2440	1820	2650	2760	2440
Width	mm	388	388	800	600	500	600	700	800	500
Crushing Force	ton	40	40	120	65	95	65	95	120	95
Rated Pressure	bar	260	260	320	280	300	280	300	320	300
Rated Flow	lpm	140-160	140-160	220-280	180-200	220-260	180-200	220-260	220-280	220-260
Working Pressure	bar	240	11 240	300	260	280	260	280	300	280
Rotating Motor Pressure	bar	-	-	-	-	-	90	120	120	120
Rotating Motor Flow	lpm	-	-	-	-	-	30-50	40-60	45-70	40-60

Multi Crusher/Multi Shear

Applicable objects: crushing and shearing operations such as building demolition and steel shearing.
 Main features: Made of Swedish Hardox 500 steel, lightweight and wear-resistant;
 The pin is made of 42CrMo alloy steel, with built-in oil passage, high strength and good toughness;
 Rotary motor adopts Swiss imported motor, full-angle rotation;
 The oil cylinder adopts honing tube, imported HALLITE oil seal, short working cycle and long life;
 The knife block is made of wear-resistant alloy steel, which is resistant to high temperature and deformation.



Double-cylinder Shear



Single-cylinder Shear

Item/Model	Unit	Double-cylinder Shear			Single-cylinder Shear			
		ZHMS10	ZHMS20	ZHMS40	ZH80V	JS180V	ZH280V	ZH380V
Suitable Excavator	ton	0.8-1.5	1.5-3.0	4-9	6-10	12-18	20-30	26-35
Weight	kg	135	210	400	360	1280	1600	2000
Opening	mm	290	350	440	390	650	730	810
Blade Length	mm	100	100	120	100	150	180	180
Height	mm	1000	1055	1330	1280	1890	2010	2120
Width	mm	660	690	770	850	1285	1350	1500
Crushing Force	ton	20	22.5	50	20	80	100	120
Cutting Force	ton	22	26	55	50	165	210	260
Driving Pressure	bar	180	210	260	250	300	300	300
Driving Flow	lpm	-	-	-	180	230	240	240
Cycle Time	Open	sec	-	-	2.1	2.9	2.9	2.9
	Close	sec	-	-	2.7	2.7	2.7	2.7

Hydraulic Quick Hitch

Applicable object: Cooperate with various types of excavators to assist quick change operation.
 Main features: using Q345 manganese plate steel, high strength and corrosion resistance;
 The pin is made of 42CrMo alloy steel with high strength and toughness;
 The oil cylinder adopts honing tube, imported HALLITE oil seal, short working cycle and long life;
 Removable tiger mouth spring disc protection design, bold design of safety pin, safe and reliable.



Item/Model	Unit	ZHMINI	ZH45	ZH50/55	ZH60/65	ZH70/80	ZH90	ZH100/110
Suitable Excavator	ton	1.5-4	4-7	5-8	9-19	17-23	23-30	33-45
Weight	kg	25	50-60	80	120-130	280-290	420-430	450-580
Length	mm	388	534-545	600	765	924-944	983-1050	1006-1473
Height	mm	246	307	310	388	492	574	558-610
Nidth	mm	175	258-263	270-280	353-436	449-483	543-568	606-663
Pin to Pin Center Distance	mm	80-150	230-270	290-360	380-420	460-480	473-540	550-620
Forearm Open Width	mm	80-140	155-170	180-200	232-315	306-340	375-411	416-469
Retractable Distance of Oil Cylinder	mm	170-206	205-275	340-450	340-486	256-390	413-590	520-590
Top to Bottom Pin Distance	mm	159	195	195	220	275	300	360
Pin Diameter	mm	25-40	45-50	50-55	60-70	70-80	80-90	90-120
Norking Pressure	bar	32-40	32-40	32-40	32-40	32-40	32-40	32-40
Working Flow	lpm	10-20	10-20	10-20	10-20	10-20	10-20	10-20

Tilt Quick Hitch

Applicable object: High-tech assisted fast operation suitable for different angle requirements.
 Main features: using NM400 plate steel, high strength and corrosion resistance;
 The pin is made of 42CrMo alloy steel with high strength and toughness;
 The oil cylinder adopts honing tube, imported HALLITE oil seal, short working cycle and long life;
 The rotator used is a hydraulic rotator imported from Italy, which has light weight and long life;
 Safety pin accurate card position design, safe and reliable.

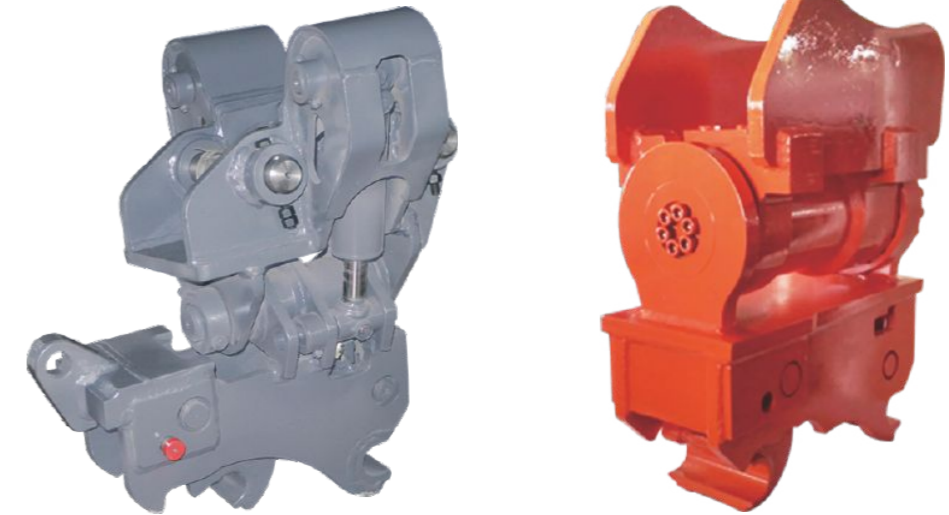

Item/Model	Unit	ZHTH06	ZHTH08
Suitable Excavator	ton	9-18	16-25
Weight	kg	550	670
Length	mm	700	970
Height	mm	890	980
Width	mm	400	850
Pin to Pin Center Distance	mm	390	465
Pin Diameter	mm	65	80
Rotation Angle	degrees	90	90
Forearm Open Width	mm	290	360
Cylinder Rotation Angle	degrees	+/-45	+/-45
Working Pressure	bar	200-220	200-220

Single Cylinder Shear

Applicable objects:the disintegration of vehicles such as motorcycles,vans,agricultural machinery and tire hub separation,the compression and volume reduction of scrap steel,the demolition of other buildings,steel shearing and other crushing and cutting operations.

Main features:using Swedish Hardox 500 steel,light weight and wear-resistant;

The pin shaft is made of 42CrMo alloy steel with built-in oil passage,which has high strength and good toughness;

The rotating motor adopts the Swiss imported motor,which rotates in full angle;

The oil cylinder adopts honing tube and imported NOK oil seal,short working cycle and long life;

The knife block is made of wear-resistant alloy steel,which is resistant to high temperature and deformation.



Item/Model	Unit	ZHS50	ZHS80	ZHS180	ZHS280	ZHS380
Suitable Excavator	ton	3-5	6-10	12-18	22-27	28-36
Weight	kg	200	365	1000	2000	3020
Opening	mm	250	376	480	600	650
Blade Length	mm	4*120	6*110	6*140	2*210	2*210
Driving Pressure	bar	200	250	300	340	340
Driving Flow	lpm	40-60	80-150	150-200	200-250	250-300
Cutting Force	ton	30	80	150	240	300

Double Cylinder Shear

Applicable objects:cutting and crushing of steel frame structures and automobile beams,dismantling of scrap automobiles and scrap metal products.

Main features:Double oil cylinders and synchronization mechanism are adopted, combining strong shearing force and light weight;

The rotating motor adopts the Swiss imported motor,which rotates in full angle;

The oil cylinder adopts honing tube and imported NOK oil seal,short working cycle and long life;

The knife block is made of wear-resistant alloy steel,which is resistant to high temperature and deformation.



Item/Model	Unit	ZHD280	ZHD380	ZHD480
Suitable Excavator	ton	22-27	28-36	37-45
Weight	kg	2650	3850	4540
Blade Length	mm	400+260	350+360	350+360
Working Pressure	bar	320	330	330
Length	mm	2380	2700	3655
Opening	mm	855	780	780
Cut Depth	mm	685	650	650
Shear Force	kN	1360	2940	2940

Grid Bucket

Excavator Model (ton)	G.W. (kg)	Hydraulic Oil Flow Rate (L/min)	Work Pressure(bar)	Bucket Capacity (cbm)
6	450	10-20	30-210	0.4
12	750	10-20	30-210	0.6
20	950	10-20	30-210	0.8
30	1200	10-20	30-210	1.4



Cleaning Bucket

Excavator Model (ton)	G.W. (kg)	Hydraulic Oil Flow Rate (L/min)	Work Pressure(bar)	Bucket Capacity (cbm)
6	450	10-20	30-210	0.4
12	750	10-20	30-210	0.6
20	950	10-20	30-210	0.8
30	1200	10-20	30-210	1.4

